

# PRECRUSHERS

## RJ-450 HD/PC RJ-575 HD/PC RJ-575 EHD/PC

Powerful RamJet® PreCrushers



RJ-575 HD/PC  
(Shown with optional hopper installed)



RJ-450 HD/PC



## PreCrusher Features

- ▼ *Ideal for bulk waste such as 55-gallon drums, wooden pallets, and skids*
- ▼ *High-force crushing ram*
- ▼ *Vertical steel crushing wall*
- ▼ *Self-cleaning gate*
- ▼ *Ideal for high hourly volumes and continuous-feed applications*

## The Worldwide Compaction Leader

Marathon® Equipment is known throughout the world as one of the leading manufacturers of quality on-site waste compaction products. The **RamJet** brand has been the industry standard for quality and innovation for more than 50 years, and includes stationary and self-contained compactors, compaction containers, apartment and high-rise compactors, pre-crushers, auger-style compactors, transfer systems, and a wide array of options for virtually any application.



Environmental  
Solutions Group®

a DOVER company

## Powerful RamJet<sup>®</sup> PreCrushers

### Overview

#### Perfect for:



Automotive Manufacturers



Equipment Manufacturers



Large Distribution Centers



Appliance Manufacturers



Transfer Stations

### Why Marathon<sup>®</sup> Equipment Is the Preferred Choice

**Marathon** brand components are selected for longevity and minimum maintenance, with special attention given to the selection of high-duty cycle components. Stress engineering provides the optimum degree of structural integrity. Only the best materials are used and the highest standards of quality are observed in the manufacturing process.

The **RamJet** family of products are state-of-the-art in compactors and feature large feed openings, and expanded container storage capacity. They are designed to optimize safety for workers, store and transport your waste, prevent contamination of public areas in accordance with public health department requirements, improve working conditions for your employees, and reduce disposal costs.

**Marathon** can custom outfit your PreCrusher application with options such as security chutes, cart dumpers, specially designed hoppers, remote controls, hand and toe rails, tread plate tops for walk-on or drive-on applications, electronic compactor controls, and Remote Monitoring System.

Select these products for weekly volumes of 500 cubic yards or more of industrial plant solid-waste or recyclable materials. These models are particularly suited for high hourly volumes or continuous-feed applications.

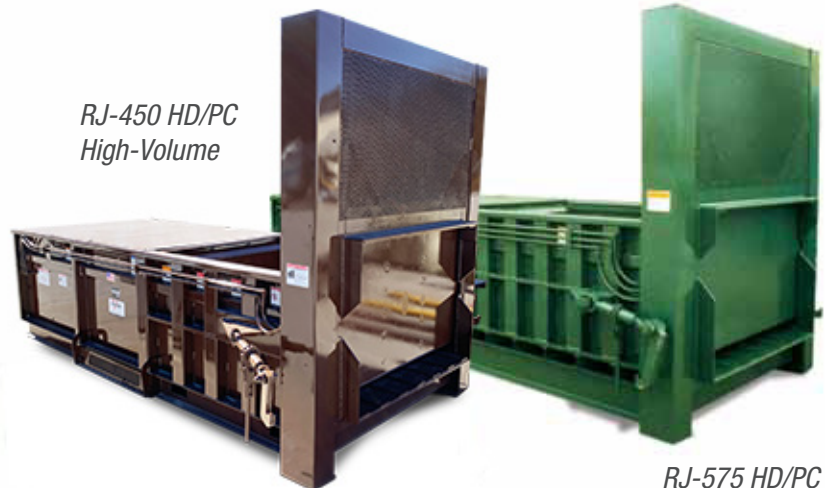

*RJ-450 HD/PC  
High-Volume*

*RJ-575 HD/PC*

### Shrink Your Disposal Costs with a Marathon PreCrusher

*Get up to 30% greater compaction results than with a standard compactor!*

A **Marathon** PreCrusher eliminates “light loads” of pallets, crates, large boxes, and drums that fill your container with air. The packing ram moves through the charge box with a high level of force that effectively crushes everything against the PreCrusher’s vertical steel wall. The wall is then raised and the ram fully extends, compacting the refuse into the attached container. Uniform compaction is achieved throughout the receiver container. **Every stroke is a crushing compaction stroke. The results: fewer trips to the landfill!**



## Powerful RamJet<sup>®</sup> PreCrushers

### Overview

### High-Performance Features and Benefits

- ▼ **High-Force Crushing Ram:** moves through the charge box, effectively crushing everything against the vertical steel wall. The wall is then hydraulically raised and the ram extends a full 13" into the compaction container on the RJ-575 HD/PC / RJ-575 EHD/PC, and 12" for RJ-450 HD/PC.
- ▼ **Guided Ram:** the packing ram movement is supported by guides, which reduces friction, improves compaction, and extends the life of the ram.
- ▼ **Vertical Steel Crushing Wall:** while in the DOWN position, it serves as an effective crushing gate to eliminate "light loads" of material that would fill your container with air.
- ▼ **Self-Cleaning Gate:** has a beveled design that prevents crushed materials from sticking to the door.
- ▼ **Low-Profile Design:** enables the units to be shipped fully assembled.
- ▼ **Heavy-Duty Construction:** the charge box, sides, ram top, floor, and faceplates are specially engineered for heavy-duty industrial applications.
- ▼ **Tongue and Groove Flooring:** prevents thin materials from becoming trapped under the ram. Optional side tongue and groove also available.
- ▼ **Programmable Controller:** standard on automatic units, the controller simplifies operation and eliminates many relays and limit switches.



### Remote Monitoring System

The Remote Monitoring System enables you to monitor your compaction and baling equipment remotely, right from your desktop or mobile device using integrated wireless communications. The system combines on-site factory built-in or external add-on hardware with an industry-leading software platform to give you real-time compactor and baler data, 24 hours per day, seven days per week. This system provides the tools to optimize your equipment and measurably reduce your waste management costs. You can eliminate unnecessary pickups, service your equipment to prevent downtime, and substantially reduce your overall carbon footprint. The remote monitoring system is also equipped with the Ozone Odor Control System, which destroys odor-producing bacteria by molecular reaction.

#### View the Compactor

- ▼ Check performance
- ▼ Monitor fullness
- ▼ Identify misuse

#### Manage the Network

- ▼ Automate the scheduling of pickups and service calls
- ▼ Track performance trends
- ▼ Identify and address areas of inefficiency

#### Stay Connected

- ▼ Receive email or text alerts on your mobile device
- ▼ Communicate important decisions from any location
- ▼ Automatically escalate missed pickups or service call notifications

#### Repairs

- ▼ Schedule service before costly breakdowns
- ▼ Keep equipment operating at peak efficiency
- ▼ Receive malfunction and online alerts
- ▼ Reduce service and replacement costs

#### Metrics

- ▼ Create a custom dashboard to view equipment data and analyze operating trends
- ▼ Identify ways to enhance performance

#### Pickups

- ▼ Automatically notify the hauler when compactors reach their desired fullness level
- ▼ Pay only for necessary pickups



# PreCrushers

## Powerful RamJet® PreCrushers

### Overview

#### Fully Automatic Operation

The RJ-450 HD/PC/High-Volume, RJ-575 HD/PC, and the RJ-575 EHD/PC are fully automatic. After pressing the “Start” button, the compaction ram crushes the material against the heavy steel wall in the charge chamber. The steel wall then automatically lifts and the crushed material is re-compacted into the receiver container. The PreCrusher then resets itself to await the next load.

#### Ideal For Crushing

- ▼ 55-gallon steel drums
- ▼ Industrial waste
- ▼ Wood pallets
- ▼ White goods
- ▼ Wood crates
- ▼ Turnings
- ▼ Spools
- ▼ Other hard-to-destroy materials

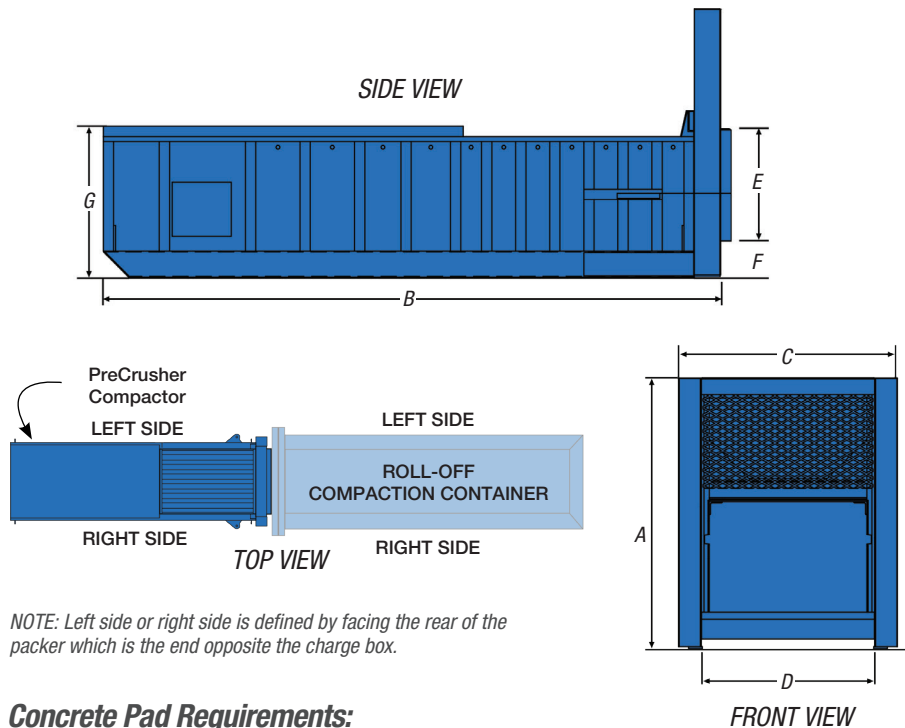

NOTE: Left side or right side is defined by facing the rear of the packer which is the end opposite the charge box.

#### Concrete Pad Requirements:

6" Thick Reinforced 3000 psi Concrete | (8) 3/4" Anchor Bolts (Min.)

Dimensions	RJ-450 HD/PC/ High-Volume		RJ-575 HD/PC		RJ-575 EHD/PC	
<b>A</b>	105"	2654mm	104 1/2"	2654mm	104 1/2"	2654mm
<b>B</b>	174 7/8"	4442mm	240 1/8"	6099mm	240 1/8"	6099mm
<b>C</b>	82 3/4"	2102mm	82 3/4"	2102mm	82 3/4"	2102mm
<b>D</b>	60"	1524mm	60"	1524mm	60"	1524mm
<b>E</b>	43 1/2"	1105mm	43 1/2"	1105mm	43 1/2"	1105mm
<b>F</b>	14 1/2"	368mm	14 1/2"	368mm	14 1/2"	368mm
<b>G</b>	54"	1372mm	54"	1372mm	59"	1499mm



#### Remote Monitoring System Optional on all PreCrushers

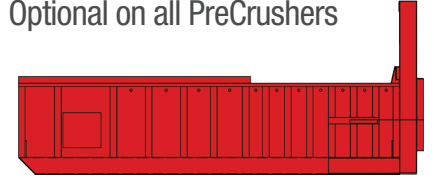

#### PreCrusher

With PLC and wireless modem

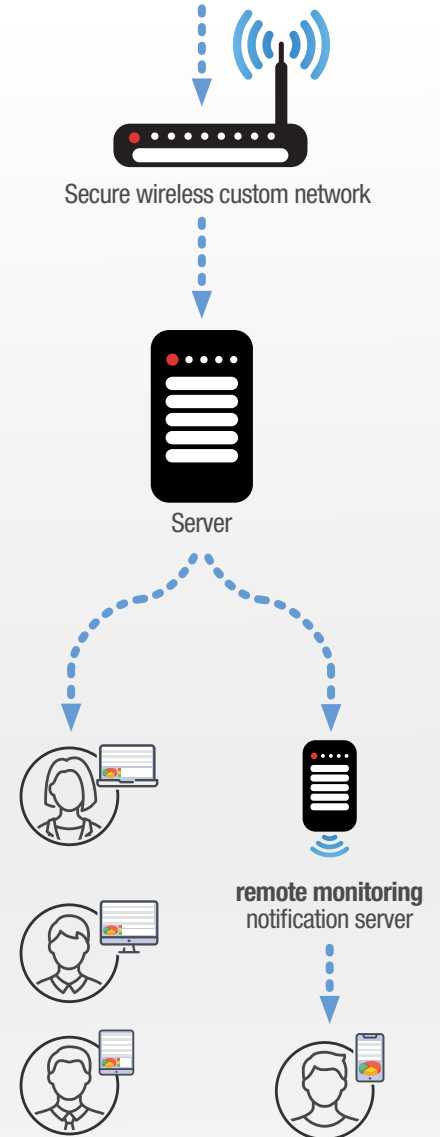

- ▼ Remote monitoring can display daily equipment status on a desktop or mobile PC, tablet, or smart phone
- ▼ Staff can login from any desktop or wireless device
- ▼ Notifications can be sent to superintendent or directly to haulers

## RJ-450 HD/PC PreCrusher

Overview

### Heavy-Duty PreCrusher

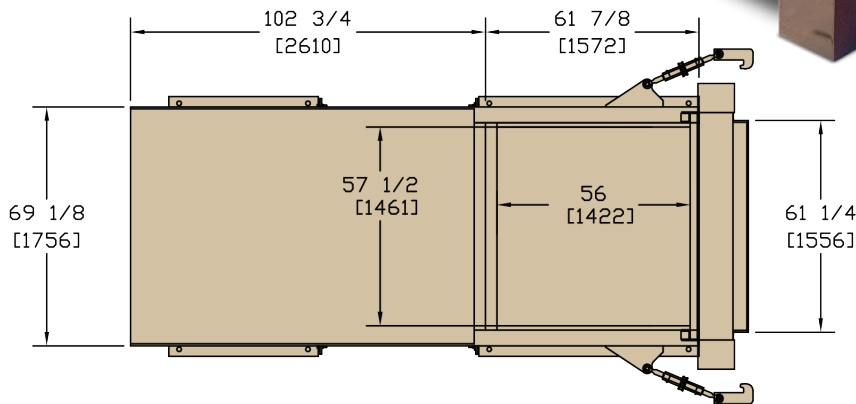
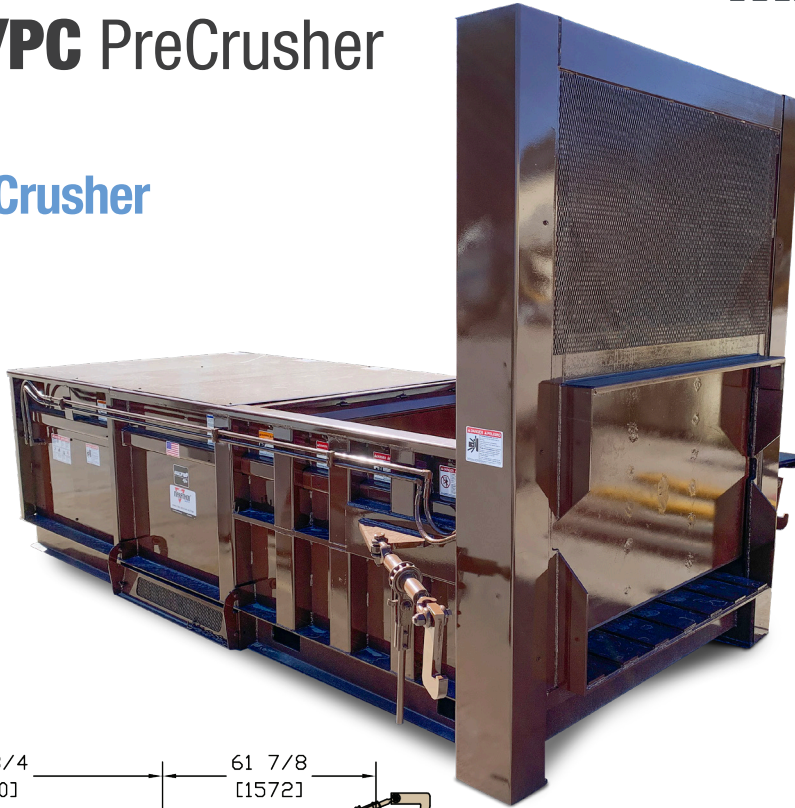

TOP VIEW

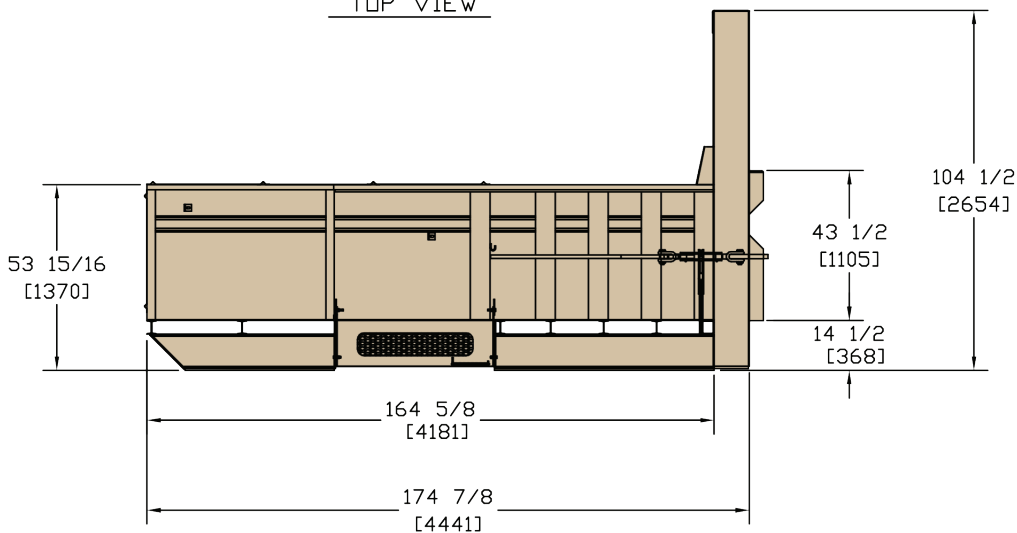

SIDE VIEW

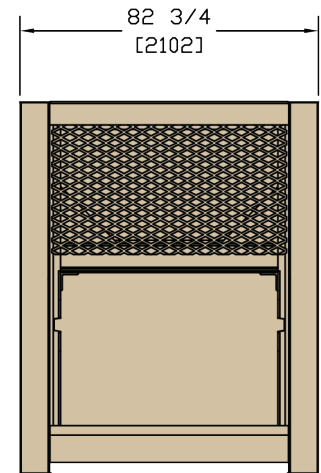

FRONT VIEW

## RJ-575 HD/PC PreCrusher

Overview

### Heavy-Duty PreCrusher

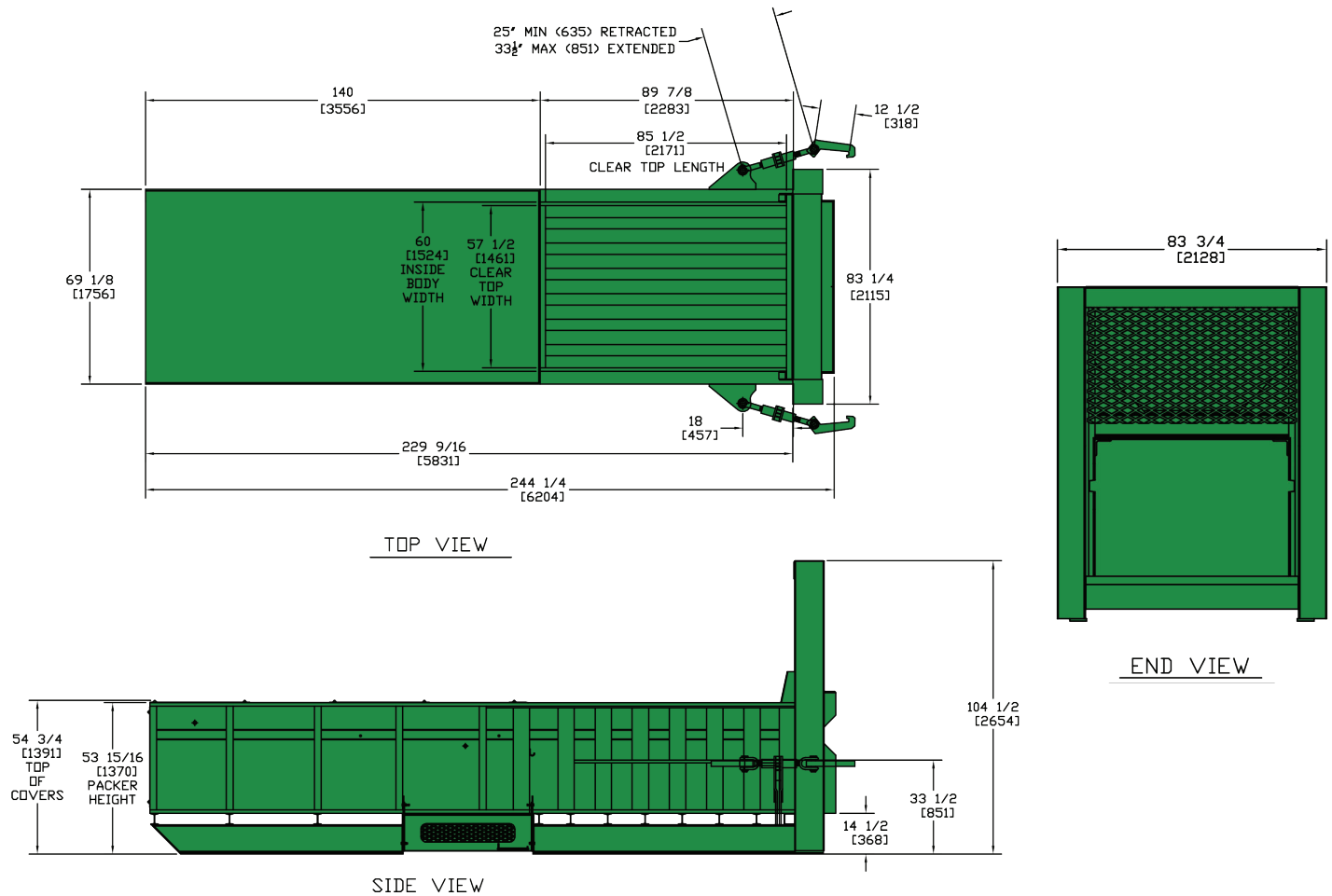

## RJ-575 EHD/PC PreCrusher

### Overview

### Extra Heavy-Duty PreCrusher

The RJ-575 EHD/PC has the heaviest construction of the PreCrusher line and is suitable for the toughest size reduction and compaction applications.

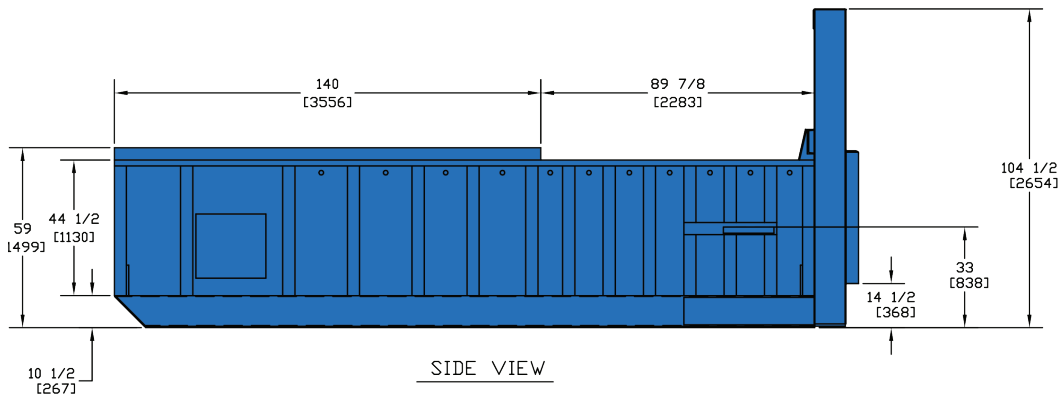
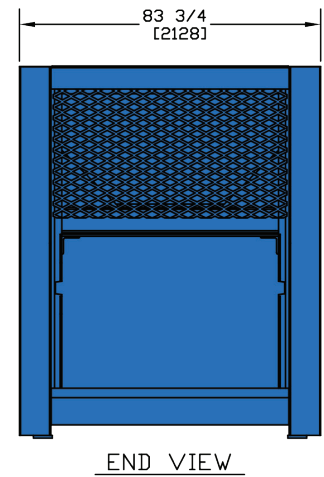
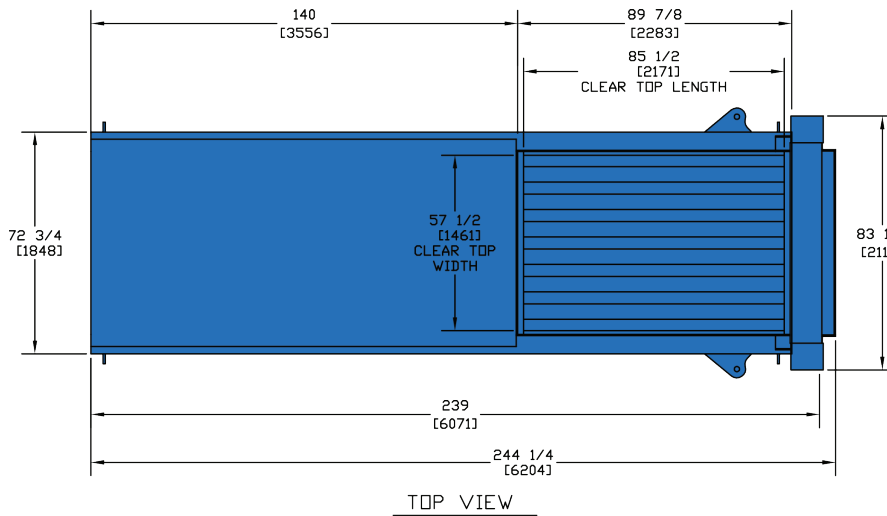

## RJ-450 HD/PC, RJ-575 HD/PC, and RJ-575 EHD/PC

### PreCrushers Dimensions & Specifications

Specifications	RJ-450 HD/PC		RJ-575 HD/PC		RJ-575 EHD/PC	
<b>Clear Top Opening (L x W)</b>	56" x 57 1/2"	1422mm x 1461mm	85 1/2" x 57 1/2"	2172mm x 1461mm	85 1/2" x 57 1/2"	2172mm x 1461mm
<b>Compactor Capacity</b>	2.90 yd <sup>3</sup>	2.22 m <sup>3</sup>	4.15 yd <sup>3</sup>	3.17 m <sup>3</sup>	4.15 yd <sup>3</sup>	3.17 m <sup>3</sup>
<b>Ram-Face Size (W x H)</b>	59" x 33 1/2"	1499mm x 851mm	59" x 33 1/2"	1499mm x 851mm	59" x 33 1/2"	1499mm x 851mm
<b>Compactor Weight</b>	14,000 lbs.	6350 kg	17,600 lbs.	7983 kg	23,000 lbs.	10433 kg
<b>Performance Characteristics</b>						
<b>Cycle Time</b>	65 sec.		51 sec.		51 secs.	
<b>Total Normal Force</b>	60,800 lbs.	270 kN	84,600 lbs.	376 kN	84,600 lbs.	376 kN
<b>Total Maximum Force</b>	69,200 lbs.	308 kN	96,200 lbs.	428 kN	96,200 lbs.	428 kN
<b>Normal Ram-Face Pressure</b>	30.8 psi	212 kPa	42.8 psi	295 kPa	42.8 psi	295 kPa
<b>Maximum Ram-Face Pressure</b>	35.0 psi	241 kPa	48.7 psi	336 kPa	48.7 psi	336 kPa
<b>Ram Penetration</b>	12"	305mm	12 1/2"	318mm	13 1/2"	343mm
<b>Electrical Equipment</b>						
<b>Electric Motor 3/60-208//230/460/575</b>	20 hp	14.9 kW	30 hp	22.4 kW	30 hp	22.4 kW
<b>Electric Control Voltage</b>	120 VAC		120 VAC		120 VAC	
<b>Standard Controls Include</b>	Three-Push Button station: Keylock Start/Stop/Reverse					
<b>Hydraulic Equipment</b>						
<b>Hydraulic Pump Capacity</b>	18.5 gpm	70 L/min	52 gpm	197 L/min	52 gpm	197 L/min
<b>Normal Pressure</b>	2,150 psi	148 bar	2,200 psi	152 bar	2,200 psi	152 bar
<b>Maximum Pressure</b>	2,450 psi	169 bar	2,500 psi	172 bar	2,500 psi	172 bar
<b>Hydraulic Cylinder(s)</b>	1		1		1	
<b>Bore</b>	6"	152mm	7"	178mm	7"	178mm
<b>Rod</b>	4"	102mm	4"	102mm	4"	102mm
<b>Stroke</b>	82"	2803mm	112"	2845mm	112"	2845mm

### Construction:

Ram-Face Plate and Bottom constructed of 3/4" steel (all models); Ram Top constructed of 1/2" steel (all models); Body Sides constructed of 1/4" steel (except for RJ-575 EHD/PC, which has 3/8" steel sides); Liner Floor constructed of 1/2" steel and the Liner Sides constructed of 3/8" steel; PreCrusher Face constructed of 3/4" steel.

Pictures and mechanical diagrams in this literature are illustrative only and may not be to scale. Specifications are subject to change without notice in order to accommodate improvements to the equipment. Certified in compliance with ANSI standard Z245.2 and all applicable OSHA Regulations. Products must be used only by trained operators in accordance with the Operator Manual, as well as applicable regulations, laws, and ANSI standards.

#### We're Here To Help!

For detailed specifications, recommendations, or to request a site survey comparing various systems, contact the Marathon® Sales Team at [MarathonSales@MarathonEquipment.com](mailto:MarathonSales@MarathonEquipment.com)

#### Authorized Dealer:



PO Box 13040 • Spokane, WA 99213  
1(800)892-7831 • Fax (509)533-1050

Serving Washington, Idaho, Montana, Oregon



Marathon Equipment Company | P.O. Box 1798 | Vernon, AL 35592-1798

Learn more about Marathon Equipment: 800.633.8974 | [www.marathonequipment.com](http://www.marathonequipment.com)